

## K-DAXI Belt Driven Axial Fan



Belt driven axial fans can be used when the motor should be out of the airstream. With its belt drive system clients can choose the revolution at the order. It comes with mounting feet as standard.



MOTOR INSULATION CLASS	F CLASS
MOTOR PROTECTION CLASS	IP 55
MOTOR EFFICIENCY CLASS	IE2-IE3
MOTOR ENCLOSURE TYPE	TEFC
MOTOR BRAND	GAMAK-VOLT-WATT
BODY MATERIAL	GALVANIZED SHEET METAL
BODY COATING	OPTIONAL
IMPELLER MATERIAL	ALUMINIUM
DUTY CYCLE	IEC Duty Cycle-S1
WORKING AMBIENT TEMPERATURE	-20 - +50 °C
DIRECTIVE	IEC-60335-2-80, ISO 1940-1

MODEL	VOLTAGE (V)	FREQUENCY (Hz)	POWER (kW)	REVOLUTION (rpm)	FLOW RATE (m³/h)	NOISE LEVEL (dB(A))	PRICE
K-DAXI 400-5-25	380	50	0,37	1.450	2.950	68	
K-DAXI 450-5-25	380	50	0,55	1.456	4.250	71	
K-DAXI 500-5-25	380	50	0,55	1.453	6.000	73	
K-DAXI 560-5-25	380	50	0,75	1.466	8.200	77	
K-DAXI 630-5-30	380	50	1,10	1.465	13.600	82	
K-DAXI 710-5-30	380	50	1,50	1.472	19.400	85	
K-DAXI 800-5-30	380	50	2,20	1.459	26.000	87	
K-DAXI 800-5-35	380	50	3,00	1.463	31.500	91	
K-DAXI 900-5-35	380	50	4,00	1.471	40.000	92	
K-DAXI 900-5-40	380	50	5,50	1.472	45.500	95	
K-DAXI 1000-5-40	380	50	7,50	1.478	55.000	96	
K-DAXI 900-8-40	380	50	11,00	1.454	47.000	96	
K-DAXI 1000-8-40	380	50	15,00	1.456	62.500	99	
K-DAXI 1000-8-45	380	50	18,50	1.458	70.000	101	
K-DAXI 1120-8-40	380	50	22,00	1.471	87.500	102	
K-DAXI 1120-8-45	380	50	30,00	1.474	96.000	104	

Values are for 0 Pa.

### OPTIONS



GRILLE GUARD	
SIZE	PRICE
400	
450	
500	
560	
630	
710	
800	
900	
1000	
1120	

DUCT FLANGE	
SIZE	PRICE
400	
450	
500	
560	
630	
710	
800	
900	
1000	
1120	

CONNECTOR	
SIZE	PRICE
400	
450	
500	
560	
630	
710	
800	
900	
1000	
1120	

RUBBER PAD	
SIZE	PRICE
400	
450	
500	
560	
630	
710	
800	
900	
1000	
1120	

SPRING	
SIZE	PRICE
400	
450	
500	
560	
630	
710	
800	
900	
1000	
1120	

PANEL	
SIZE	PRICE
5,5 kW	
7,5 kW	
11,0 kW	
15,0 kW	
18,5 kW	
22,0 kW	
30,0 kW	

## OPTIONS

- Electro-Static Powder Coating
- Custom Fans For Specific Flow Rate and Pressure
- 5, 8, 12, or 16 Blade Fan
- Aluminium or Plastic Blades
- System Automation
- Two-Speed Motor

## DRAWING

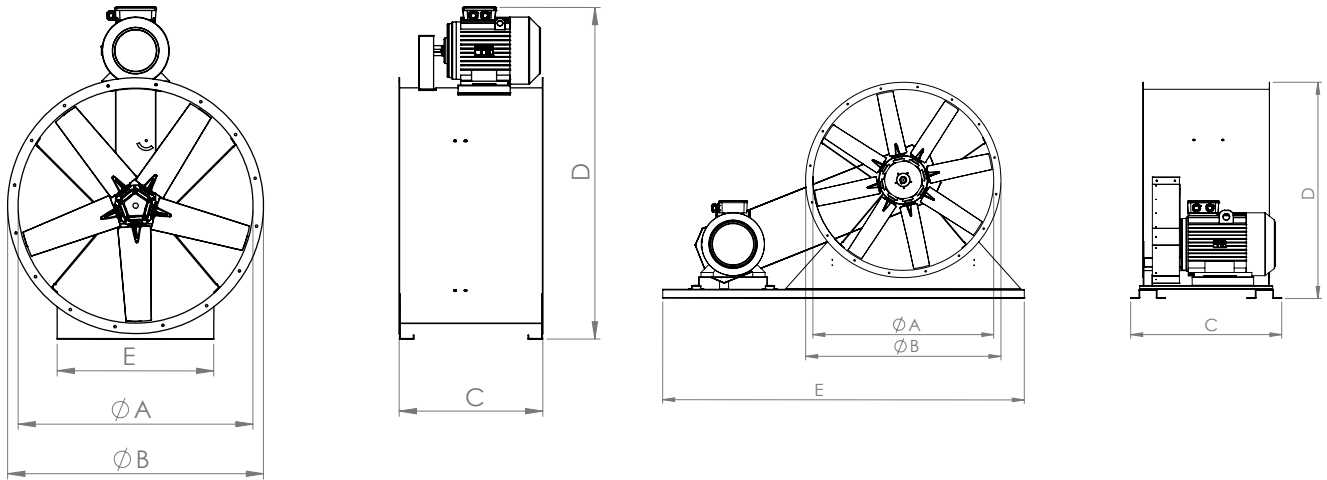

MODEL	A (mm)	B (mm)	C (mm)	D (mm)	E (mm)
K-DAXI 400	400	480	380	660	300
K-DAXI 450	450	530	400	720	330
K-DAXI 500	500	580	400	770	360
K-DAXI 560	560	640	430	840	400
K-DAXI 630	630	710	500	925	440
K-DAXI 710	710	790	500	1005	480
K-DAXI 800	800	880	500	1110	520
K-DAXI 900	900	980	740	1360	560
K-DAXI 1000	1000	1080	740	1470	600

MODEL	A (mm)	B (mm)	C (mm)	D (mm)	E (mm)
DAXI 1000	1000	1080	740	1470	600
DAXI 1120	1120	1200	520	11	16

Since motor cannot be mounted on top of the fan in model 1000-8-45 and bigger ones both fan and the motor are mounted on a separate platform.

## PERFORMANCE CURVES

K-DAXI 400-5-25

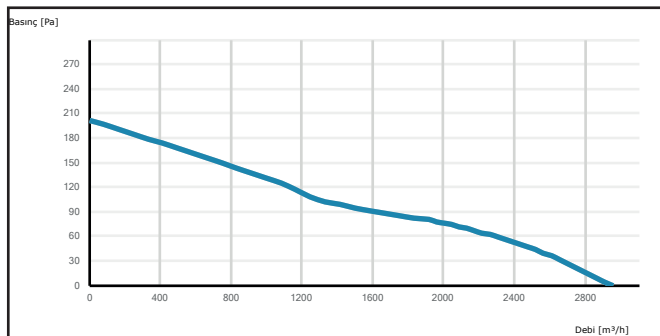

K-DAXI 450-5-25

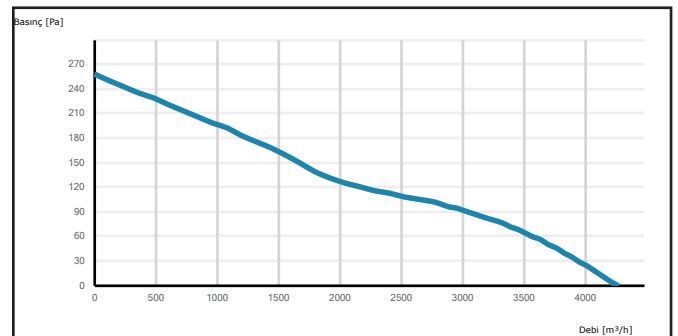

K-DAXI 500-5-25

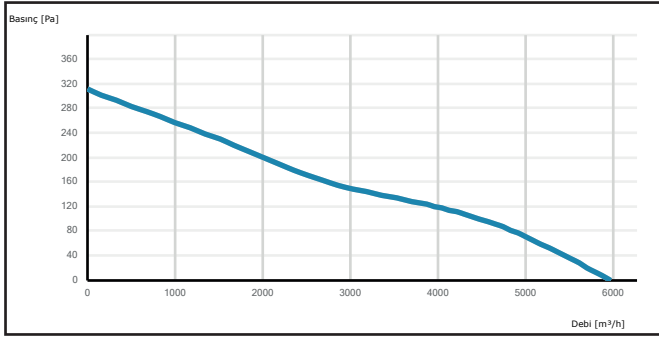

K-DAXI 560-5-25

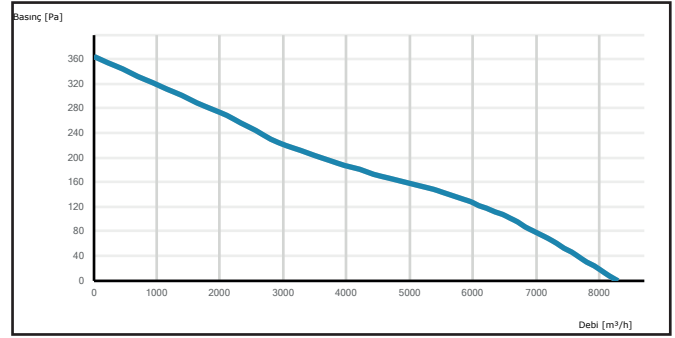

K-DAXI 630-5-30

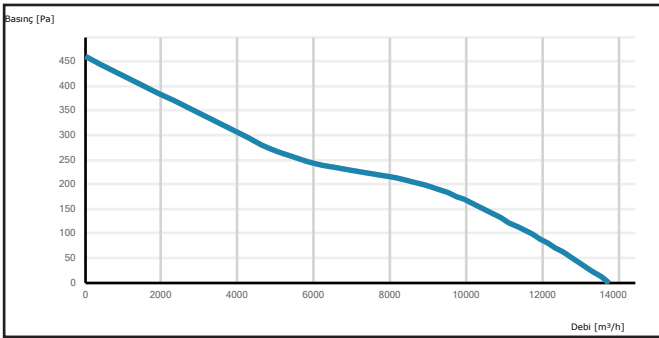

K-DAXI 710-5-30

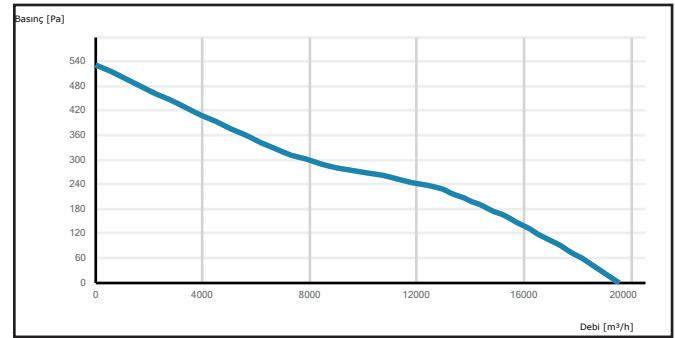

K-DAXI 800-5-30

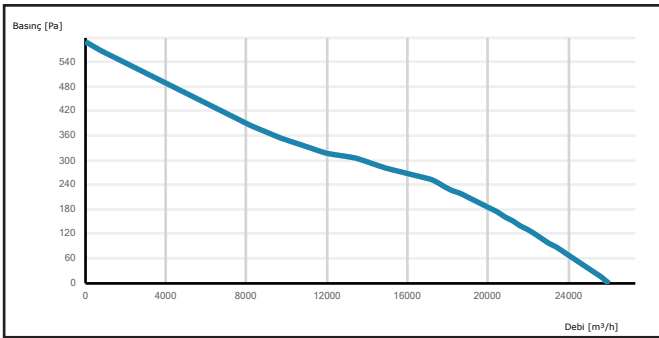

K-DAXI 800-5-35

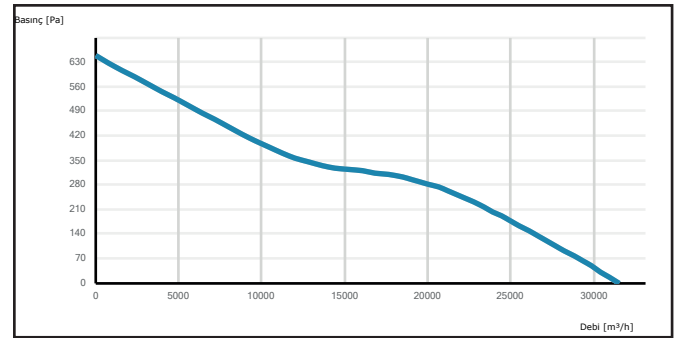

K-DAXI 900-5-35

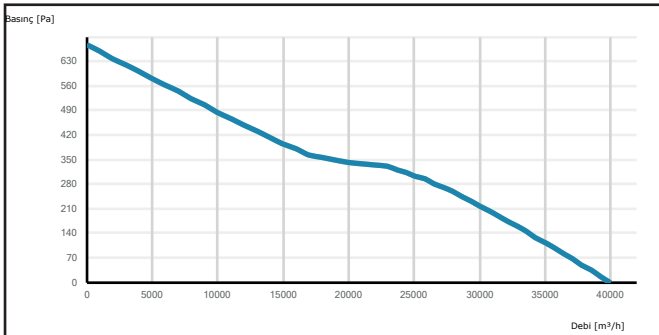

K-DAXI 900-5-40

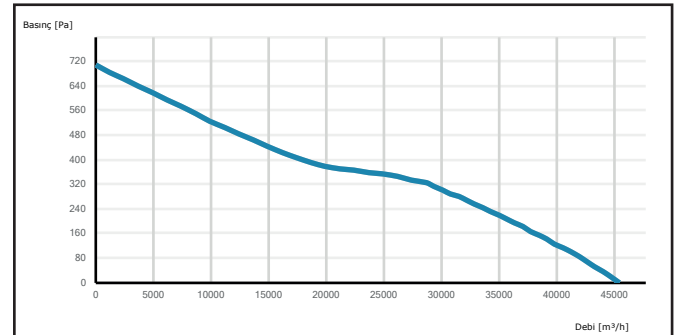

K-DAXI 1000-5-40

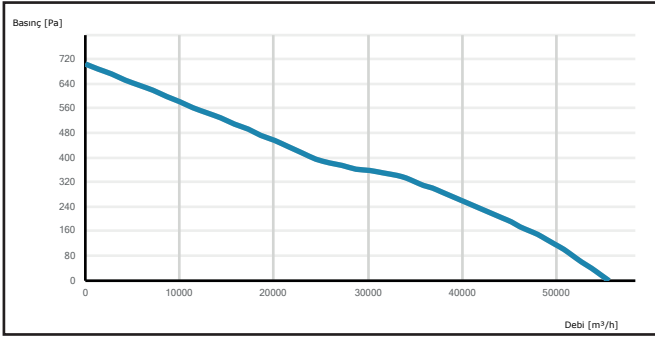

K-DAXI 900-8-40

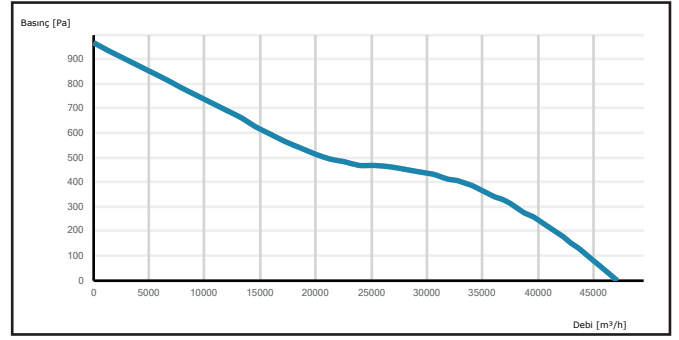

K-DAXI 1000-8-40

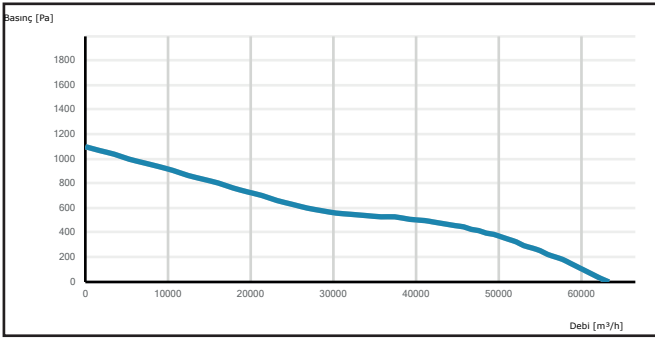

K-DAXI 1000-8-45

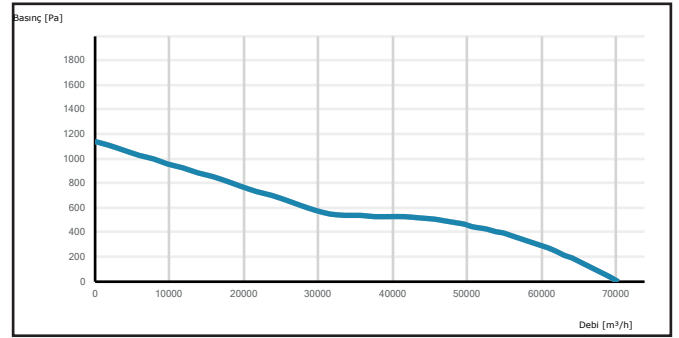

K-DAXI 1120-8-40

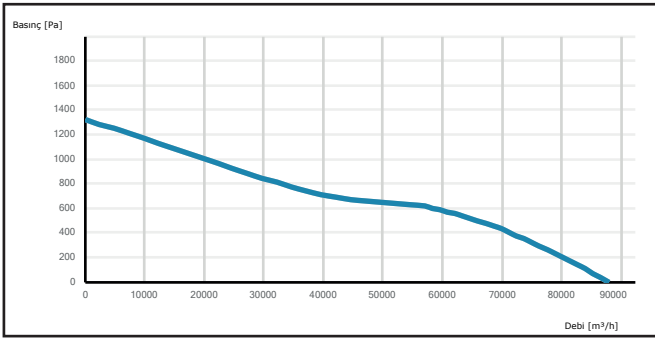

K-DAXI 1120-8-45

