

K-PAXI Axial Fan With Ex-proof Motor



K-PAXI fans have motors that do not produce sparks and with the aluminium band in the body it can be used to in ventilation with ATEX needs Zone 1 ve Zone 2 Group: IIA, IIB ve IIC. ATEX CLASS CHOICE IS THE CLIENTS RESPONSIBILITY.



MOTOR INSULATION CLASS	F CLASS
MOTOR PROTECTION CLASS	IP 55
MOTOR EFFICIENCY CLASS	IE2
MOTOR ENCLOSURE TYPE	TEFC
MOTOR BRAND	ELPROM-WEG
BODY MATERIAL	GALVANIZED SHEET METAL
BODY COATING	OPTIONAL
IMPELLER MATERIAL	ALUMINIUM
DUTY CYCLE	IEC Duty Cycle-S1
WORKING AMBIENT TEMPERATURE	-20 - +50 °C
DIRECTIVE	IEC-60335-2-80, ISO 1940-1

MODEL	VOLTAGE (V)	FREQUENCY (Hz)	POWER (kW)	REVOLUTION (rpm)	FLOW RATE (m³/h)	NOISE LEVEL (dB(A))	PRICE
K-PAXI 450-5-25	380	50	0,55	1.456	4.250	69	
K-PAXI 500-5-25	380	50	0,55	1.453	6.000	72	
K-PAXI 560-5-25	380	50	0,75	1.466	8.200	75	
K-PAXI 630-5-30	380	50	1,10	1.465	13.600	80	
K-PAXI 710-5-30	380	50	1,50	1.472	19.400	83	
K-PAXI 800-5-30	380	50	2,20	1.459	26.000	85	
K-PAXI 800-5-35	380	50	3,00	1.463	31.500	89	
K-PAXI 900-5-35	380	50	4,00	1.471	40.000	90	
K-PAXI 900-5-40	380	50	5,50	1.472	45.500	93	
K-PAXI 1000-5-40	380	50	7,50	1.478	55.000	94	
K-PAXI 900-8-40	380	50	11,00	1.454	47.000	94	
K-PAXI 1000-8-40	380	50	15,00	1.456	62.500	97	

Values are for 0 Pa.

OPTIONS



GRILLE GUARD	
SIZE	PRICE
450	
500	
560	
630	
710	
800	
900	
1000	



SUPPORT FEET	
SIZE	PRICE
450	
500	
560	
630	
710	
800	
900	
1000	



DUCT FLANGE	
SIZE	PRICE
450	
500	
560	
630	
710	
800	
900	
1000	



CONNECTOR	
SIZE	PRICE
450	
500	
560	
630	
710	
800	
900	
1000	



RUBBER PAD	
SIZE	PRICE
450	
500	
560	
630	
710	
800	
900	
1000	



SPRING	
SIZE	PRICE
450	
500	
560	
630	
710	
800	
900	
1000	

OPTIONS

- Custom Fans For Specific Flow Rate and Pressure
- 5, 8, 12, or 16 Blade Fan
- System Automation
- Choice For Different ATEX Classes

DRAWING

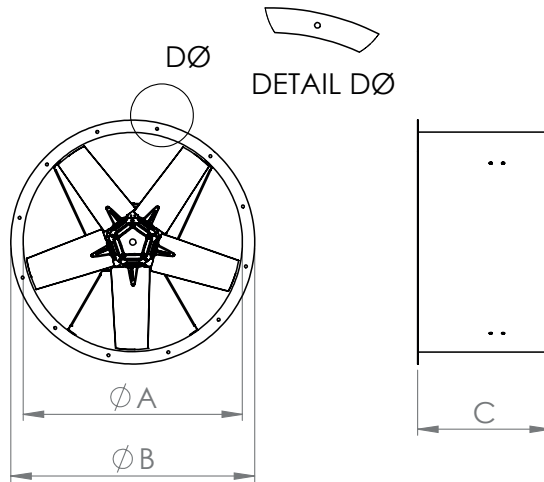

MODEL	A (mm)	B (mm)	C (mm)	D (mm)	N
K-PAXI 450	450	530	320	11	8
K-PAXI 500	500	580	320	11	8
K-PAXI 560	560	640	320	11	12
K-PAXI 630	630	710	420	11	12
K-PAXI 710	710	790	420	11	12
K-PAXI 800	800	880	420	11	16
K-PAXI 900	900	980	520	11	16
K-PAXI 1000	1000	1080	520	11	16

N: Number of Holes

PERFORMANCE CURVES

K-PAXI 450-5-25

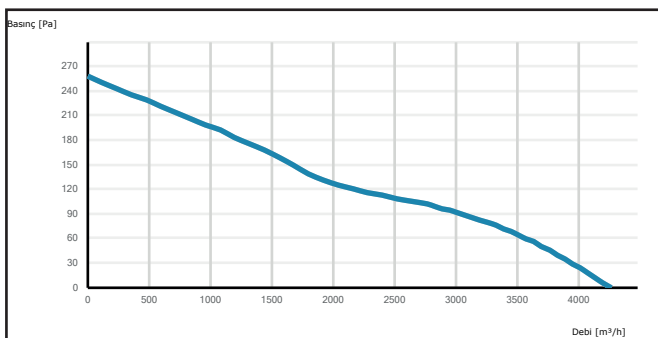

K-PAXI 500-5-25

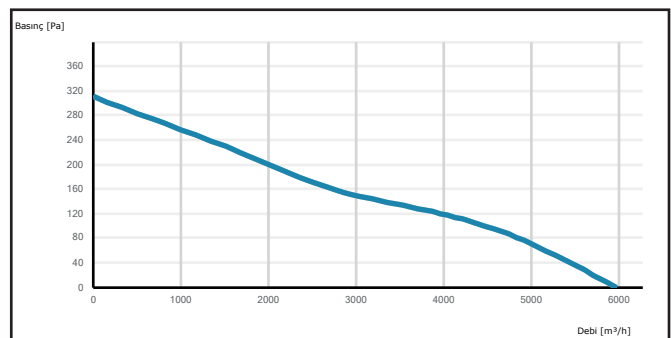

K-PAXI 560-5-25

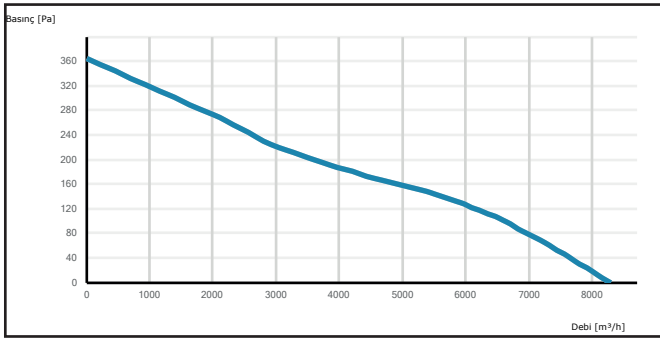

K-PAXI 630-5-30

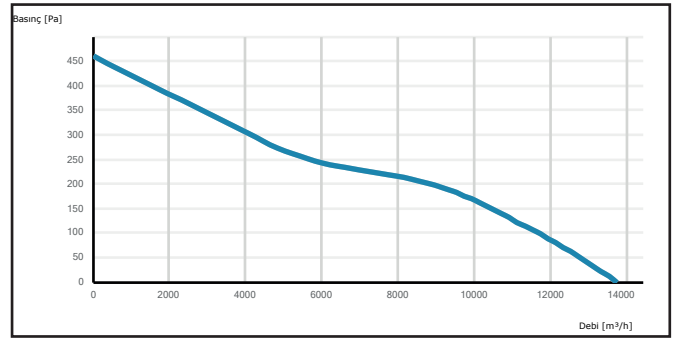

K-PAXI 710-5-30

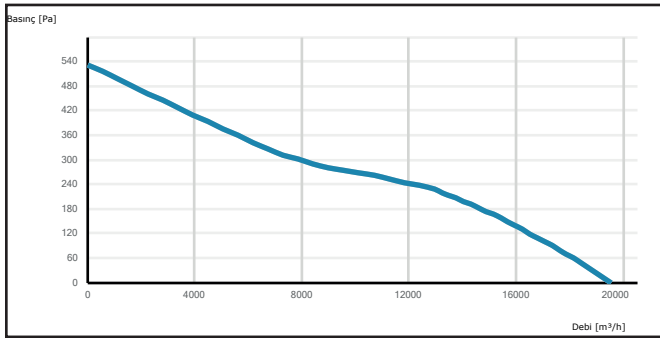

K-PAXI 800-5-30

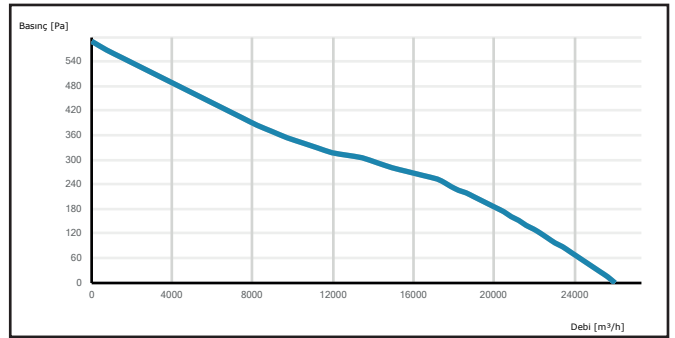

K-PAXI 800-5-35

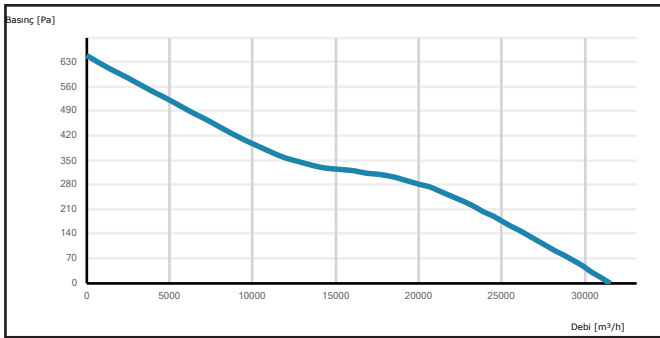

K-PAXI 900-5-35

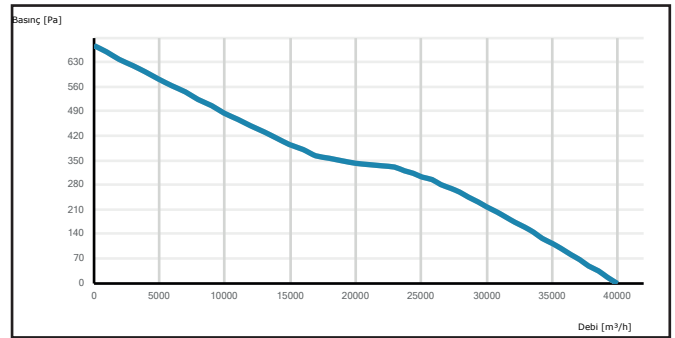

K-PAXI 900-5-40

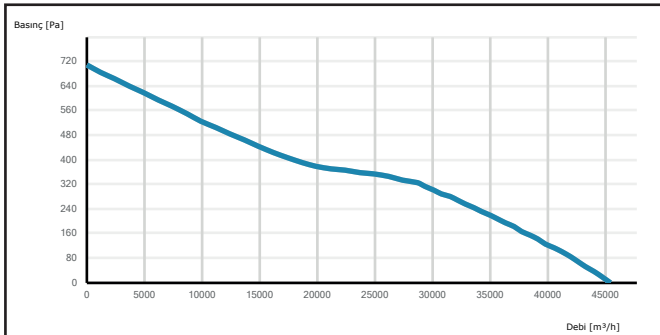

K-PAXI 1000-5-40

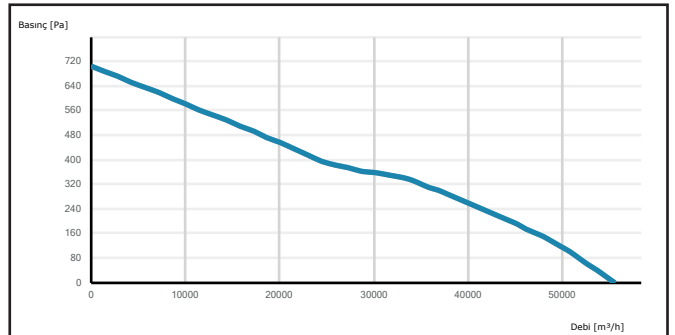

K-PAXI 900-8-40

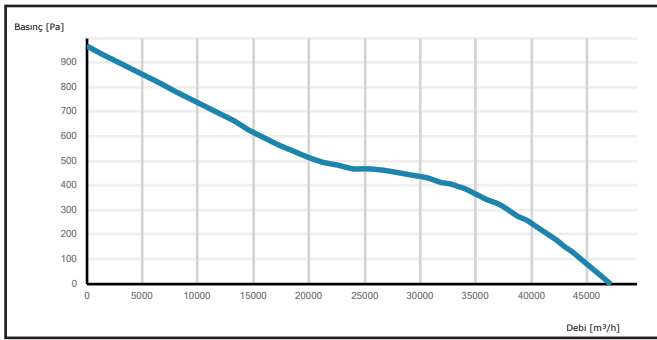

K-PAXI 1000-8-40

